



MOUNT PLEASANT

smart
architectural aluminium

Alitherm Heritage

The ideal window and door solution for heritage applications such as listed building renovations where planning regulations demand a like-for-like replacement window with optimum thermal performance.

- Window Energy Rating B
- U Value 1.5 W/m²K (using sealed unit 1.0 W/m²K)
- BS 6375 Part 1: 2009 Resistance to Weather

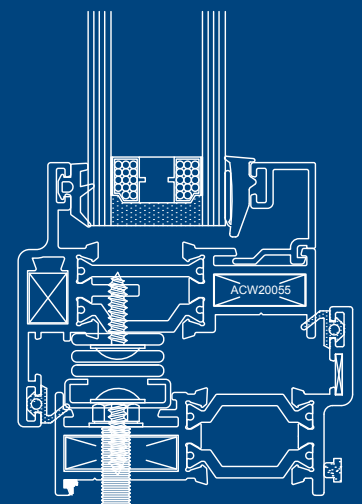
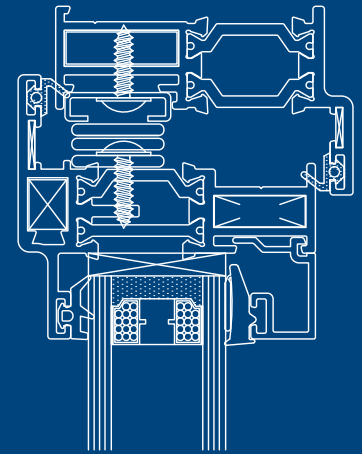

Alitherm Heritage Window

Alitherm Heritage provides the ideal solution for heritage applications such as listed building renovations and large scale replica-refurbishment projects where planning constraints are to be considered.

The Alitherm Heritage window is designed to be built as a series of horizontal modules which can be stacked using horizontal couplers to form a multi-part window featuring a specially design drip bar between modules.



Application

- Fixed windows
- Single or double sash, side hung open out casements
- Top hung open out casements
- Pivot windows

Features

- Polyamide thermal break provides enhanced thermal performance
- Designed as a direct replacement for steel windows

Finish

Single or dual colour, marine quality polyester powder coat as standard

Technical Performance

WER Rating	B
U Value	1.5 W/m ² K (using sealed unit 1.0 W/m ² K)
Air	Class 4, 600Pa
Water	Class 9A, 600Pa
Wind	Class AE, 2400Pa

Document L Compliant

Dimensions

Frame Depth	47mm
Glass	24mm, 28mm, 32mm & 36mm

Test Certification

BS 6375 Part 1: 2009 Resistance to Weather

Recommended Design Limits

- Side Hung Vent Max o/a width: 700mm
- Side Hung Vent Min o/a width: 300mm
- Side Hung Vent Max o/a height: 1400mm
- Maximum Vent weight: 40kg
- Top Hung Vent Max o/a width: 1400mm
- Top Hung Vent Max o/a height: 1300mm
- Top Hung Vent Min o/a height: 275mm
- Maximum Vent weight: 35kg

Smart Systems Limited

Arnolds Way | Yatton | Bristol | North Somerset | BS49 4QN | UK
T +44 (0) 1934 876 100 | **F** +44 (0) 1934 835 169 |
W www.smartsystems.co.uk | **E** sales@smartsystems.co.uk
 IMS123AH.201504

Alitherm Heritage Door

The Smart Alitherm Heritage door is the ideal replacement for steel balcony doors on heritage applications such as building renovations or apartment conversions. The Alitherm Heritage door provides the solution for conservation areas where planning regulations require a like-for-like product replacement.

Alitherm Heritage door profiles feature the system's signature slim sightlines and elegant lines that complement Smart's existing Alitherm Heritage window and mimic those of steel doors. The system has all the advantages of modern aluminium profiles that feature polyamide thermal breaks, allowing the system to achieve a U Value of 1.5 W/m²k when installed with a suitable sealed unit.

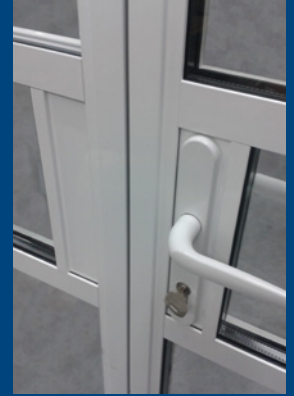

Application

- Single or double doors

Features

- Slim sightlines
- Tape or gasket glazed
- Multi point locking and face mounted shoot bolts

Technical Performance

U Value	1.5 W/m ² K (using sealed unit 1.0 w/m ² K)
Air	Test result pending
Water	Test result pending
Wind	Test result pending
Glass	24mm – 32mm
Typical Sightlines	59mm

Recommended Design Limits

Max Width	900mm
Max Height	2100mm

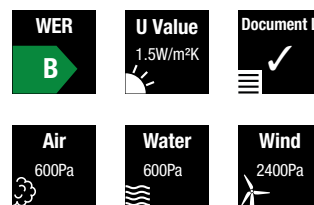
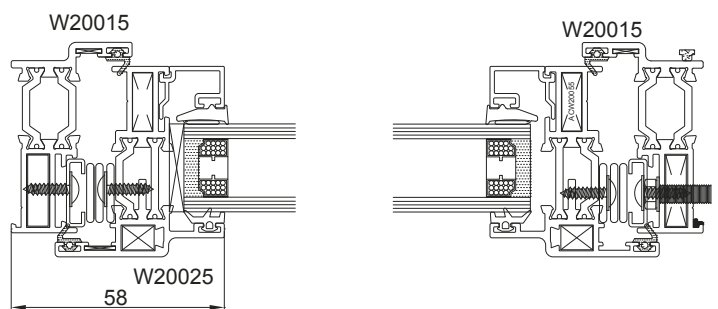

The images, drawings and data shown in this brochure are for illustrative purposes only and are not binding in detail, colour or specification. We reserve the right to make changes to the product specification as technical developments dictate and without prior notice. We recommend that the user ensures that they are satisfied the product meets their requirements prior to purchase. ©Smart Systems Ltd 2014